

SERVICE TRUCK – 9 FT ALUMINUM

**4007
SERIES**

TECHNICAL SPECIFICATIONS

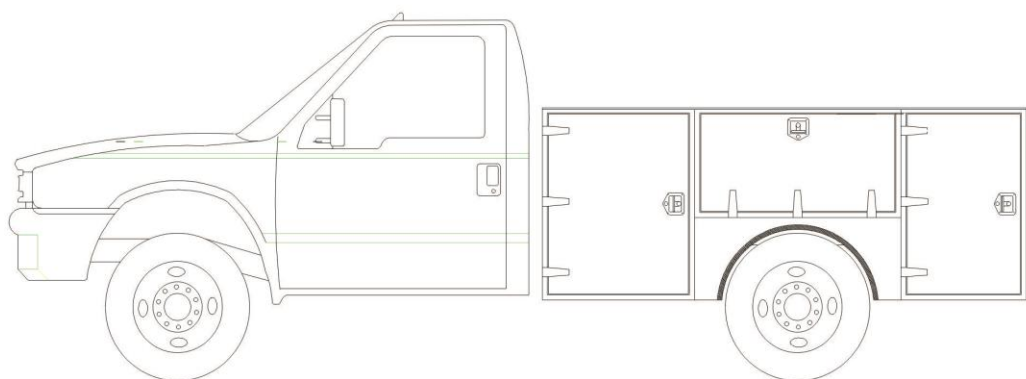
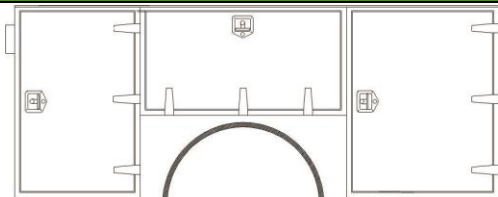

SPECIFICATIONS

CAB TO AXLE REQUIRED	60"	
BODY WIDTH	80"	
SIDE HEIGHT	42"	
SIDE DEPTH	14"	
CARGO DECK WIDTH	51 1/4"	
TAILGATE HEIGHT	10"	
STORAGE CAPACITY	131 SQUARE FEET	
CABINET DIMENSIONS	WIDTH	HEIGHT
CURB SIDE 1ST	34"	42"
CURB SIDE 2ND	NA	NA
CURB SIDE HORIZONTAL	46"	24"
CURB SIDE REAR	28"	42"
STREET SIDE 1ST	34"	42"
STREET SIDE 2ND	NA	NA
STREET SIDE HORIZONTAL	46"	24"
STREET SIDE REAR	28"	42"

JOMAC LTD
182 Scio Road
Carrollton, Ohio 44615

Phone: 800-755-4488
Fax: 330-627-2508
Website: www.JOMACLTD.com